

Article number: 0101135  
 Description: Retaining ring A 175 DIN 471  
 Spring steel  
 Note: Fitted with ZGA pilers

## Measures

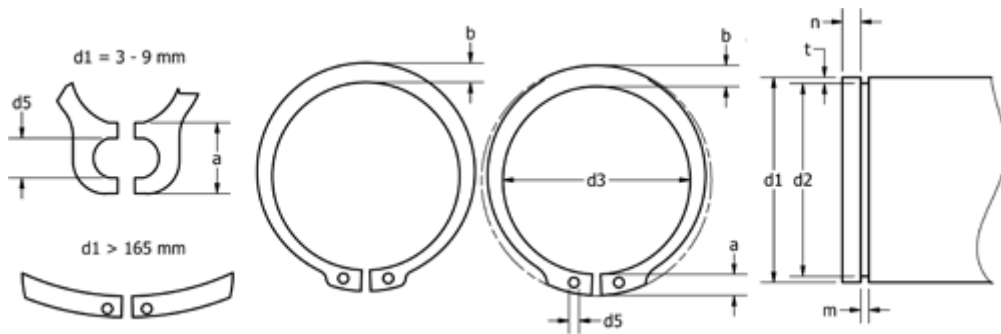

a max	= 13.5	FN kN	= 225.0	s	= 4.00
AN mm <sup>2</sup>	= 1353.0	FRg kN	= 40.70	t	= 2.50
b	= 12.9	FR kN	= 340.00	tol	= -0.63
d1	= 175	g	= 5.0	tol	= -0.10
d2	= 170.0	K kN-mm	= 785.00	tol	= +0,63-1,50
d3	= 165.5	m min	= 4.15	Tong	= ZGA-5
d5 min	= 4.0	n abl x 1000	= 2.0	Weight kg/1000	= 180.000
Description	= A175	Nominal drive	= 7.5		